



FILTER SPECIALISTS, INC.
Innovative Solutions. Clear Results.

X100

CONVERTIBLE FILTER HOUSING



Meeting & Exceeding World Production Standards... And Yours.

FSI has been serving the industry for over 30 years and has earned ISO 9001 certification and worldwide recognition as a one-source provider of liquid filtration solutions.

At FSI, we control the manufacturing process of all of our components, helping us to provide you with products that are not only top quality, but cost effective too.

FSI fabricates liquid filtration products to meet or exceed international manufacturing specifications. In fact, many of our products have established new standards for industrial filtration.

With production facilities in Europe, South America, China and North America, FSI serves markets worldwide. When your product depends on quality, you can depend on FSI.

FSI FILTER SPECIALISTS, INC.
Innovative Solutions. Clear Results.

X100 Convertible Filter Housing

The Right Choice for Many Applications and for Many Reasons

FSI's X100 Convertible Filter Housing provides an excellent, low-cost alternative to other types of filter housings.

FSI X100 is Lightweight and Chemical-Resistant

Manufactured from polypropylene with a UV inhibitor for all-weather durability, X100 housings are strong, lightweight and economical. Resistant to a wide range of chemicals for a wide range of industrial applications, the X100 will precisely fit your particular needs.

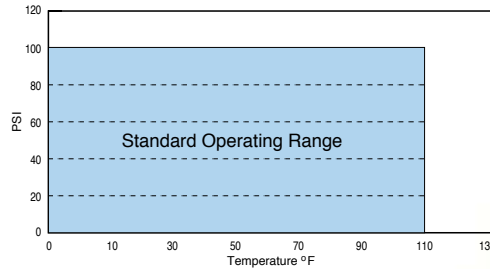

Operating Range for X100 Filter Housing

Easy Cleaning is Another X100 Trademark

FSI engineered the X100 convertible filter housing with a "clean wall" design, a smooth interior surface that allows faster, easier manual cleaning or in-place flushing.

The X100 Filter Housing is Convertible

Designed to accept either a bag filter or a cartridge filter, the FSI X100 filter housing allows you to choose the filter media and construction to precisely fit your filtering needs.

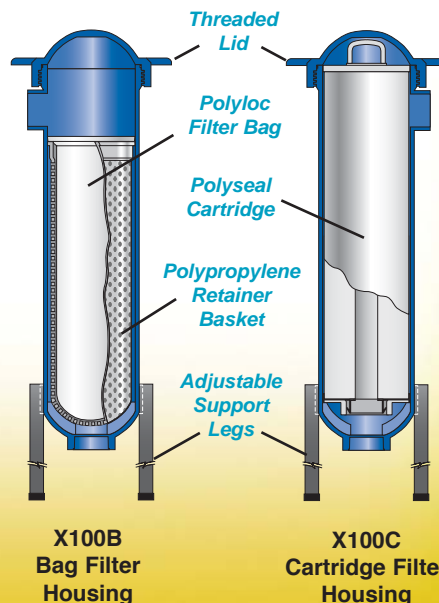

FSI
filter specialists inc.

No Sump Disassembly Required for Filter Changes

Because the X100 is top loaded with a specially developed threaded lid and gasket, filter elements can be changed without disassembling the sump and without additional tools for tightening. With the X100, changing the filter requires much less time than with many other types of filter housings.

Positive Sealing of Both Bag and Cartridge Filters

The X100 Convertible Filter Housing, along with the Polyloc® seal point of our X01 filter bags and the Polyseal seal point of our X20 filter cartridges, creates a positive seal and eliminates the chance of fluid by-pass.



Additional X100 Attributes

The X100 Convertible Filter Housing can be easily converted to accept either a filter bag or filter cartridge.

To convert the housing:

- To filter bag operation: order the X100 Plastic Basket.
- To filter cartridge operation: order the Cartridge Plate and Plate Gasket.

Replacement parts for the X100 Convertible Filter Housing are also available through FS.

At FS, Service and Technology Work Together to Provide Filtration Solutions

In addition to the X100 filtering system, FS offers a broad line of vessels, filters, custom filter products, adsorbent media and accessories to fit most filtration requirements.

FSI team members are committed to working with our customers to create effective filtration solutions. If your goals are to reduce costs and increase efficiencies in your liquid filtration processes, call FS today. We will begin the dialogue by having a direct sales representative or dealer gather vital information about your facilities, operations and processing requirements. Experienced FS engineers will then work with you to design and build a liquid filtration system that specifically meets your needs.

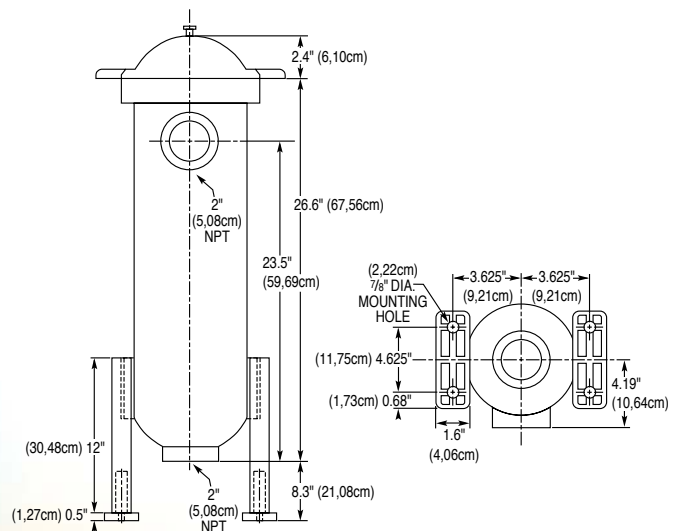

FSI X100 Filters

Whatever your application, FSI's X100 filter housing is highly adaptable. A choice of filter elements and a complete line of accessories allow the X100 to be your best filter choice.

X01 Filter Bag

Measuring 6" in diameter by a length of 20", the X01 Filter Bag has 2 square feet of surface area (0.186 square meters), making it equivalent to a standard #1 size bag. The X01 is fitted with the patented Polyloc® Ring that seals directly against the wall of the filter housing and eliminates the chance of fluid by-pass.

A heavy-duty Polypropylene Restrainer Basket supports the X01. The Polyloc® Ring sits directly against the basket collar for additional bag support.

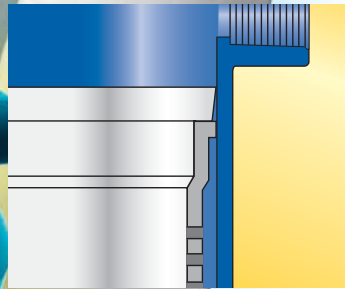

Filter Bag Seal

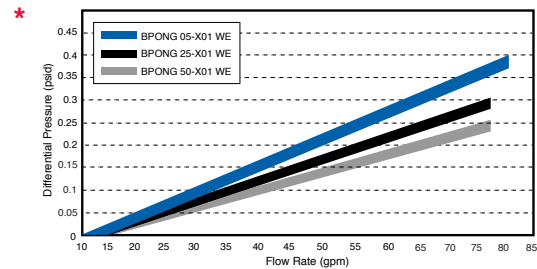

Clear Water Pressure Drop FSI BPONG X01 Bags

X20 Filter Cartridge

The X20 Cartridge is a steep pore gradient, depth filter designed to have a large dirt loading capacity. The X20 measures 5.5" in diameter, with a length of 23.25", yielding a total cartridge volume of 500 cubic inches. In laboratory tests, the X20 has outperformed standard 10" cartridges by holding 20 times the volume of dirt.

The design of the X20 Polyseal Cartridge features a single open end that directs fluid from outside the cartridge in through the filter. A built-in handle on the cartridge top assists in seating and removing the X20. The cartridge bottom is equipped with FSI's patented Polyseal End Fitting to ensure a by-pass-free sealing without the need for double O-rings or flat gaskets. Fitting securely into the cartridge plate, the X20 does not require springs, hold-down plates or center posts.

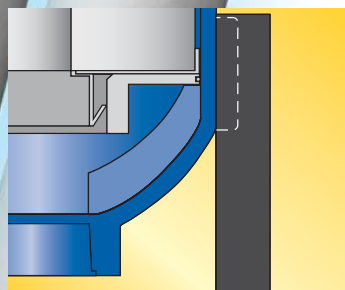
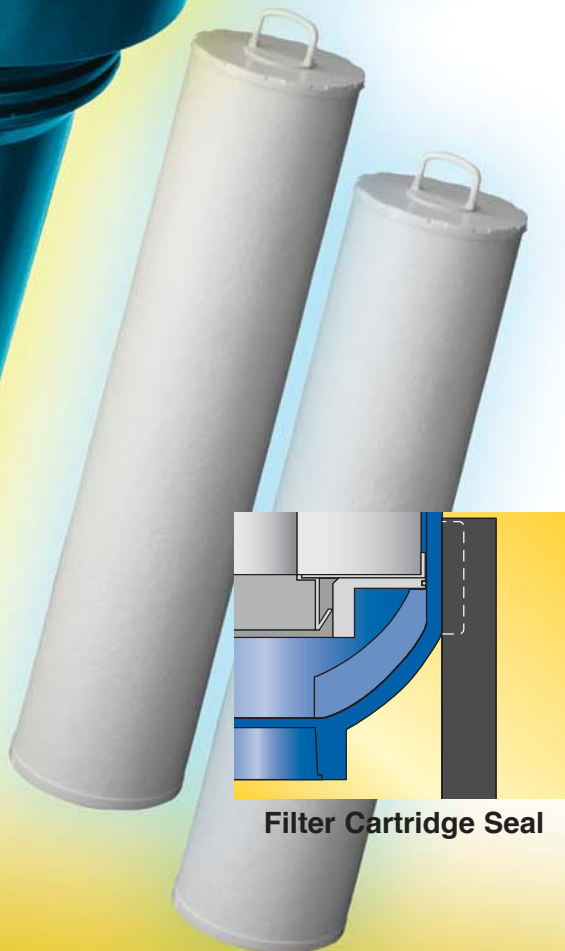

Filter Cartridge Seal

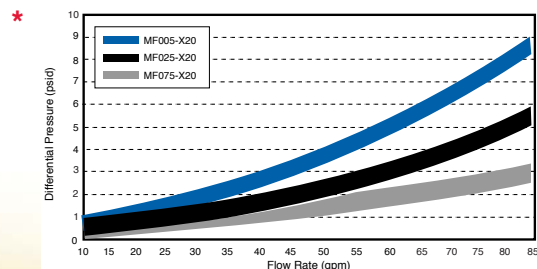

Clear Water Pressure Drop FSI X20 Cartridges 5.5" OD 23.25" Length

FSI X100 Accessories

X100 Plastic Leg Stands

Lightweight molded plastic leg assemblies are designed to mount directly on the X100 Convertible Filter Housing, providing an economical means for supporting the vessel during installation and operation.



X100 Plastic Leg Stand

X100 Metal Leg Stands

Tripod leg stands are available in either carbon steel or 304 stainless steel for heavy-duty vessel support. Dual rubber-lined metal bands and bolt tightening assemblies assure a secure installation.



X100 Metal Leg Stand

Cone Base Stand for the X100

The X100 Cone Base Stand comes with the option of a 2" NPT elbow or a T-pipe fixture to suit different piping configurations. Made of 100% polypropylene, the cone base can be mounted directly to the floor to form a solid base for the housing.



X100 Cone Base Stand

DPGX100 Series Differential Pressure Gauge

FSI offers a simple, effective, and economical way to maintain optimum performance of the X100 filter system by indicating the proper time to change out filter elements. The visual indicator changes from green (clean filter media) to red to alert the user that the filter is dirty.



X100 Differential Pressure Gauge

- Available in two pressure ranges: 6-8 PSID or 15-20 PSID
- Made of glass-filled nylon/stainless steel wetted materials (check for compatibility)
- Includes a Viton Seal/Teflon-coated spring

Metal Wall Mounting Brackets

Mounting Brackets offers maximum flexibility for application configurations. Sturdy construction; metal bands can be positioned along bracket to accommodate piping, gauges and lids.



X100 Wall Mounting Brackets

- Available in carbon steel or stainless steel

* Maximum flow rate GPM is the MAXIMUM FLOW RATE recommended through the vessel without filter cartridges installed using water as a base. Any increase in fluid viscosity, or the installation of filter cartridges, will reduce the maximum GPM figures significantly. To achieve the filtration efficiency required, the suggested maximum flow rate is 45-50 GPM.

X100 CONVERTIBLE FILTER HOUSING

FEATURES

BENEFITS

Filter Elements Top Loaded	No sump disassembly
Polypropylene Construction	Lightweight, Chemically Resistant
Convertible	Uses Cartridges or Bags
Positive Sealing	No Fluid By-pass
Clean Wall Design	Easy Access for Manual Cleaning or In-Place Flushing
FDA, NSF and CE Mark	Meets Certification Requirements

HOUSING SPECIFICATIONS - ASME Code Not Required

Model No.	Description	Includes
X100B	Plastic Bag Vessel (BUNA)	Housing, Lid, Basket, Lid Gasket (BUNA)
X100C	Plastic Cartridge Vessel (BUNA)	Housing, Lid, Cartridge Plate, Lid Gasket & Plate Gasket (BUNA)

Pressure Rating: 100 PSIG @ 110°F Water Service. Approximate Weight: 10 lbs. Port Size: 2" NPT or 2" BSP Threads available. Lid Vent: 1/4" NPT. FDA approved and with CE mark.

BAG & CARTRIDGE FILTERS

Part No.	Description	Micron Rating	Material	Element Seat
BPONG [] X01	Filter Bag	1,5,10,25,50,100	Polypropylene	Polyloc Ring®
BPMO [] X01	Filter Bag	100,150,200,300,600,800	Polypropylene	Polyloc Ring®
BPOMF [] X01	Filter Bag	1, 2, 10, 25, 90, *	Polypropylene	Polyloc Ring®
CMMF [] X20	Filter Cartridge	1, 5, 10, 25, 50, 75, 100	Polypropylene	Polyseal**

* BPOMFOAX01 Filter Bag is a Special Purpose Bag with a Micron Rating of 25.

** Provides a socket-fit positive seal in a single open-end cartridge design. Based upon a single-pass filtration test in accordance with ASTM F795-88 procedure.
Note: One FSI Polyseal Cartridge has 20 times the capacity of a standard 10" cartridge.

OPTIONS & REPLACEMENT PARTS

Description	Part No.	Description	Part No.
Replacement Lid - No Gasket	36028PTBU 1/4 NPT	304 Stainless Steel Tripod	281276B
X100 Plastic Basket	36002	Lid Gasket (BUNA)	EGT 30096B
Cartridge Plate	R36005PPBU	Lid Gasket (Viton®)	EGT 30096VI
(2) Plastic Leg and Foot Assembly	36017	Plate Gasket (BUNA)	EGR 134X4VI
Carbon Steel Tripod Legs	281276A	Plate Gasket (Viton®)	EGR 134X4VI

Selected items protected by one or more of the following patents: US Patent No. 5527463, 5514275, 5137632. Patent No. 5514275 issued May 7, 1996.

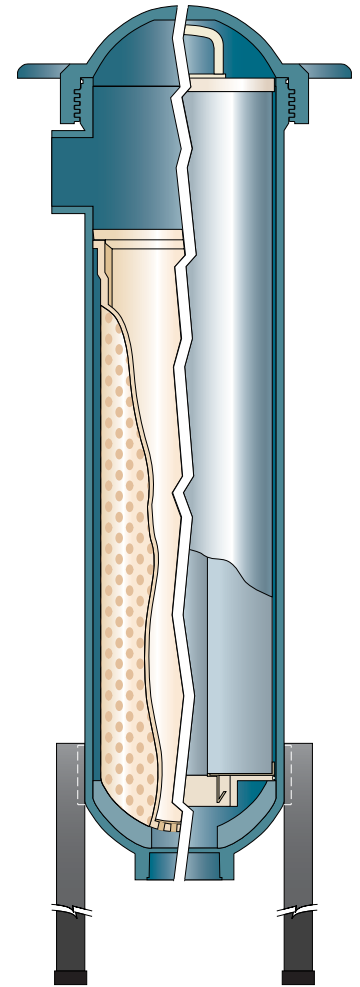

**X100 Convertible
Filter Housing**

Distributed By:

FILTER SPECIALISTS, INC. is a leader in filtration products. For more information on other products and services visit www.fsifilters.com or email sales@fsifilters.com

UNITED STATES

Filter Specialists, Inc.
100 Anchor Road
P.O. Box 735
Michigan City, Indiana 46360
219.879.3307
800.348.3205
FAX 219.877.0632

EUROPE

**Filter Specialists,
International GMBH**
Valter Weg 3.1
D-65817 Eppstein-Bremthal
Germany
011.49.6198.58080
FAX 011.49.6198.580815

NORTH AMERICA

Filter Specialists, Inc. De Mexico
Camino Temixco A Emiliano Zapata
KM. 3 Numeros 4A Y 4B, Colonia Palo
Escrito, Emiliano Zapata
Cuernavaca, Morelos C.P. 62760
Mexico
011.52..777.368.3411
FAX 011.52.777.368.3410

SOUTH AMERICA

FSI SUL Americana Industrias
Rua Oneda
671 Bairro Planalto
Sao Bernardo Do Campo
Sao Paulo, Brazil
Cep 09895-280
011.55.11.4341.6840
FAX 011.55.11.4341.6464

CHINA

**Filter Specialists
(Shanghai) Co. LTD**
Shen Xia Lu Kou
West Cheng Cheng Lu, Ma Lu,
Shanghai 201816
P.R. of China
011.86.21.5951.6662
FAX 011.86.21.5951.1662



Viton is a registered trademark of Dupont Dow Elastomers.
X 100-002-904
All information copyrighted 2004